

# FPD-5228

See-Thru Fireplace

## KINGSTON

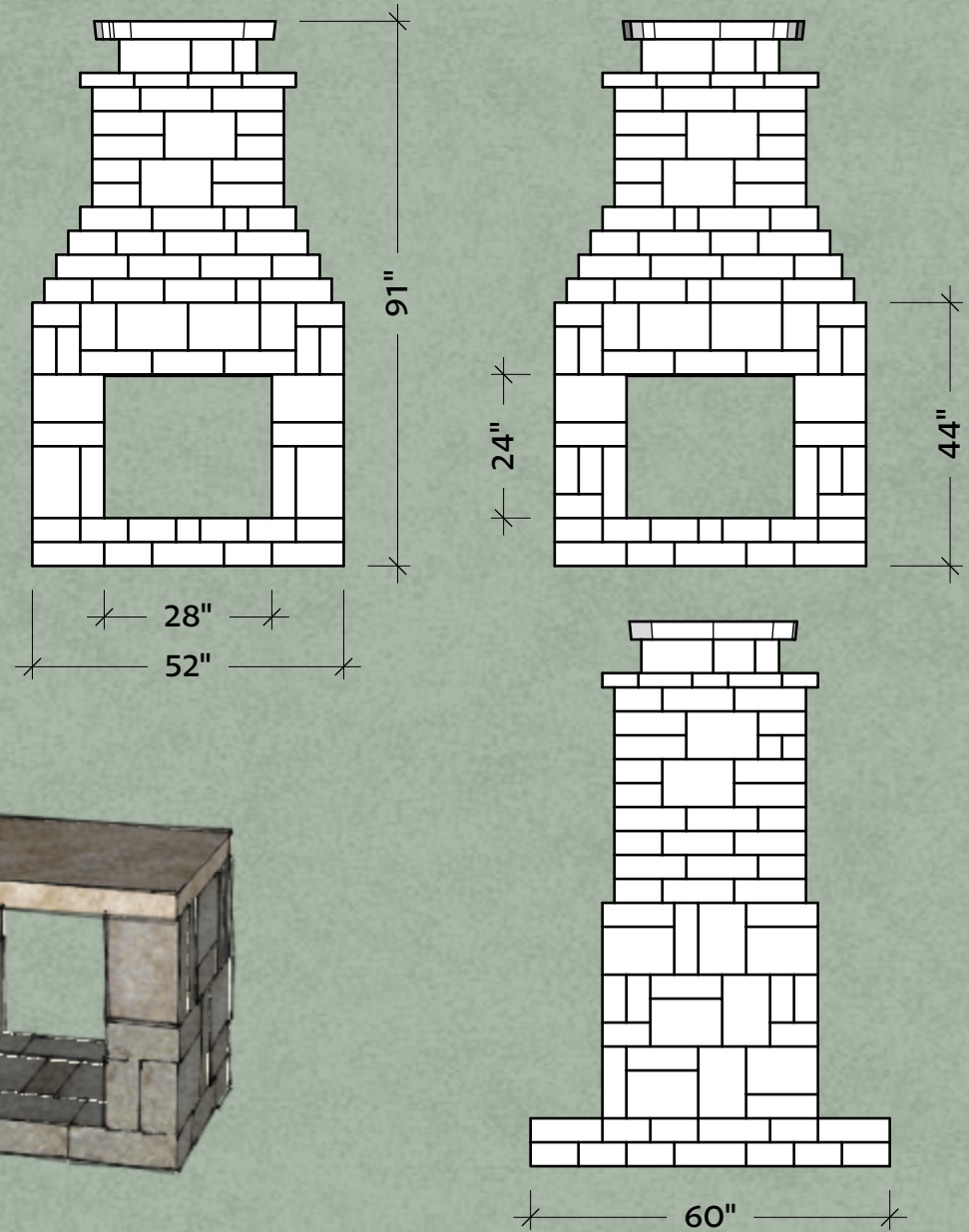
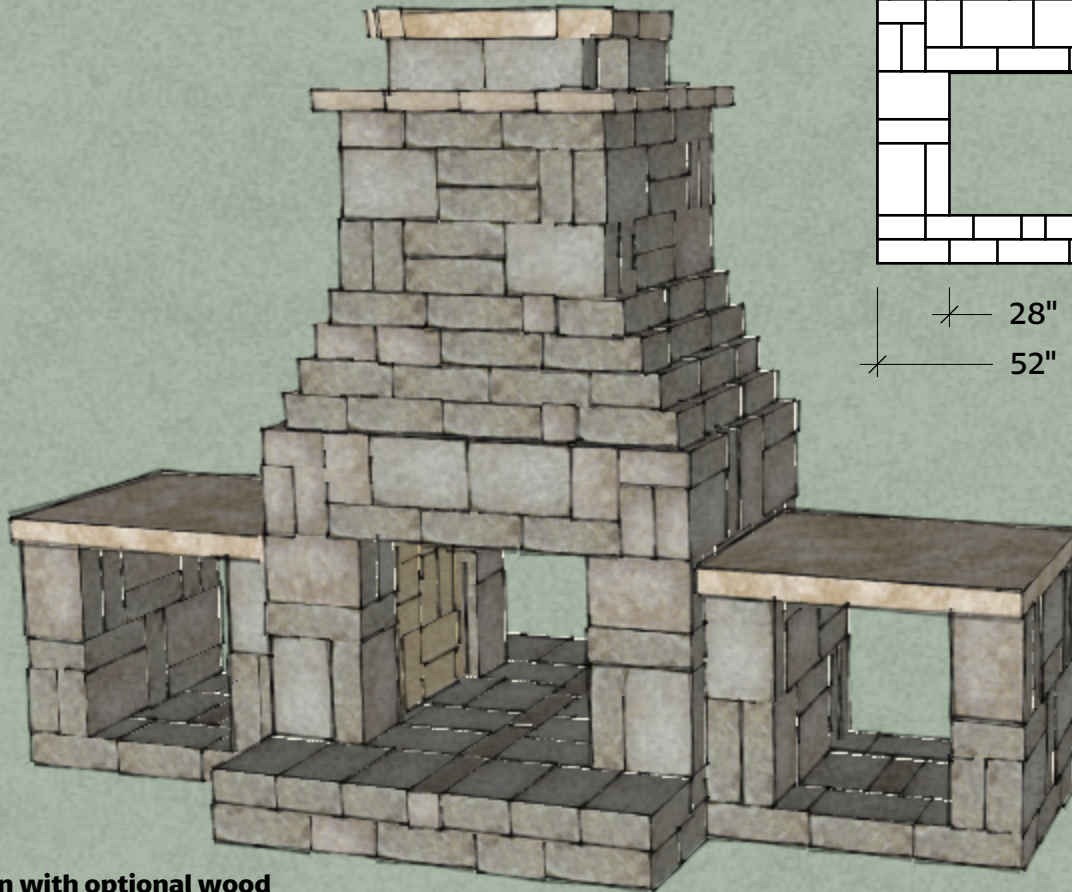

Shown with optional wood storage boxes which are not included.

Dakota Stone™

Step by step instructions for assembling FPD-5228 on a prepared surface/base.

**BUILD WITH  
DAKOTA**

All sizes in this document are approximate.

This set of instructions assumes you are building on a level grade on a level foundation.

**Materials Needed:**

- 220 Dakota Stone™ (4x8x12) **Buy 232**
- 2 Square Block (8x8x4)
- 4 Half Block (6x8x4)
- 4 Third Block (4x4x8)
- 6 Long Halves (4x4x12)
- 4 Lintel Block w/ notch
- 1 Cap Block (27x27)
- 14 6x9 Ledge Rock
- 30 Fire Brick
- 2 Angle Iron (34")
- 12 Tubes Adhesive

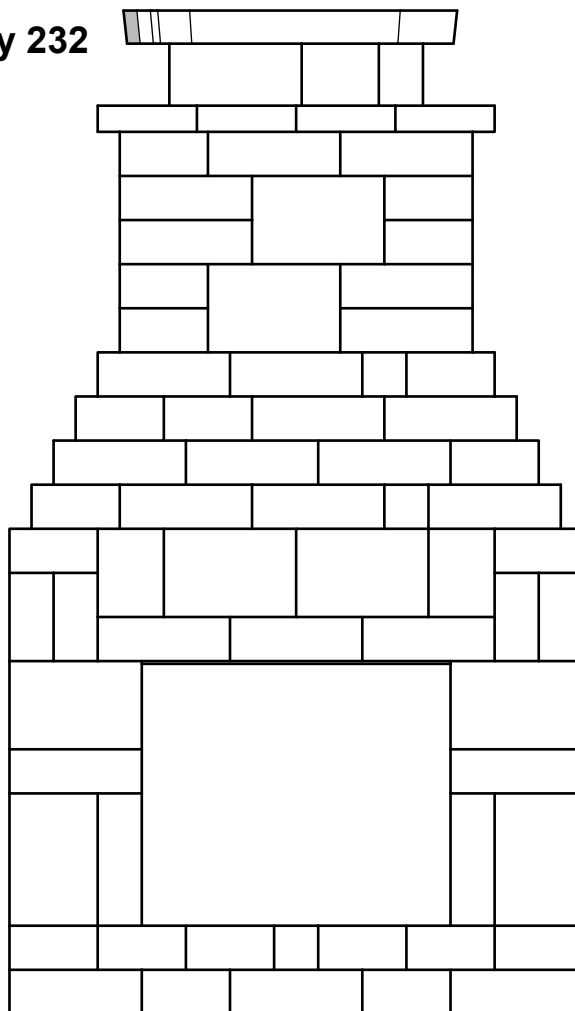

**Tools Needed:**

- Dead Blow Hammer
- Caulk Gun
- 4 Foot Level
- Torpedo Level
- Square
- Ladders

When constructing your project, be sure to keep all blocks level, square, and plumb. Use a four foot level and check often. Starting on a level foundation is key. When gluing blocks together, be sure not to use too much adhesive - this will cause the blocks to "swim." A small bead is ideal.

**Dakota Stone™**

**BUILD WITH  
DAKOTA**

**FPD-5228**

See-Thru Fireplace

REVISIONS

	MM/DD/YY	REMARKS
1	06/04/15	2 SKU and QR update
2	--/--/--	...
3	--/--/--	...
4	--/--/--	...
5	--/--/--	...

**INFO**

All sizes in this document are approximate.

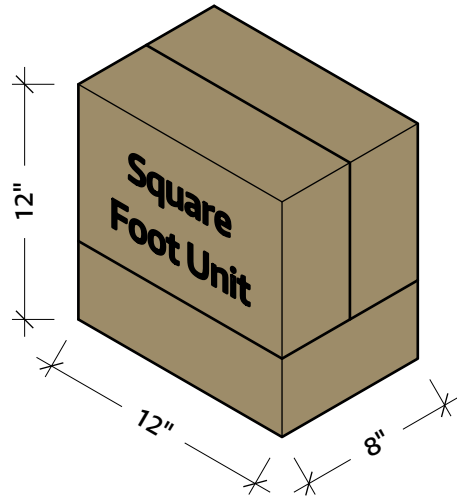

The "Square Foot Unit." consists of three block as shown. By rotating this unit (SFU) we are able to build quickly and easily while keeping bond lines broken up. These will always be shown in a tan color.

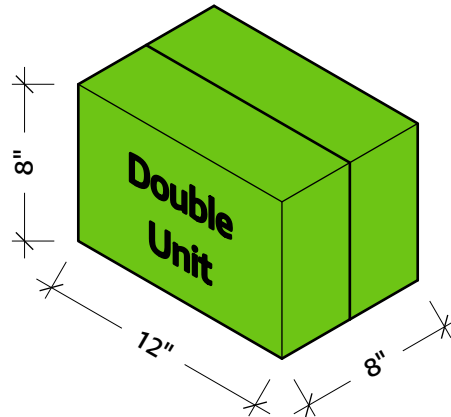

Sometimes SFUs are broken up or can't be used. The Double Unit is the next preferred unit. Double Units are grouped for strength and speed in construction. They are always represented in green.

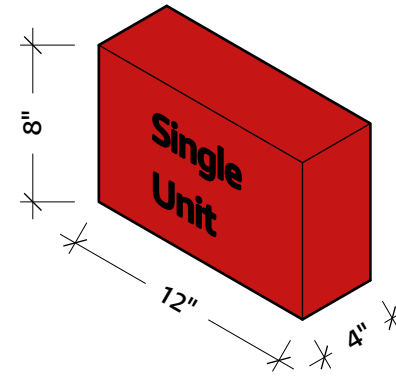

The Single Unit is the basis for all the construction, of course. When used in a single or non-standard configuration, you will see Dakota Stone™ depicted in red.

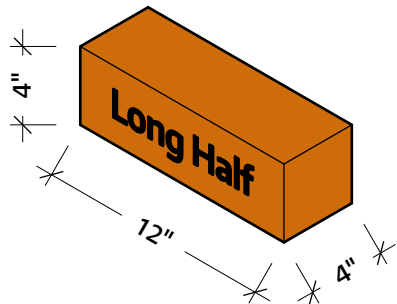

Long Halves are simply made by cutting a block along its center on the longest axis.

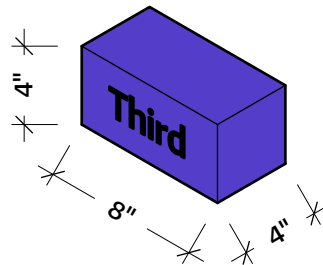

Cutting four inches off the short end of a Dakota Stone will get you a Third block (and a Square one).

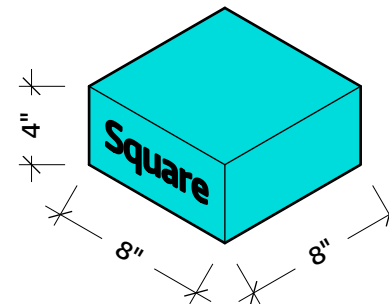

Cutting four inches off the short end of a Dakota Stone will get you a Square block (and a Third one).

## Unit Size Color Key

When constructing your project, be sure to keep all blocks level, square, and plumb. Use a four foot level and check often. Starting on a level foundation is key. When gluing blocks together, be sure not to use too much adhesive - this will cause the blocks to "swim." A small bead is ideal.

Dakota Stone™

**BUILD WITH  
DAKOTA**

**FPD-5228**

See-Thru Fireplace

REVISIONS

	MM/DD/YY	REMARKS
1	06/04/15	2 SKU and QR update
2	---/---/---	...
3	---/---/---	...
4	---/---/---	...
5	---/---/---	...

**KEY1**

All sizes in this document are approximate.

## Unit Size Color Key

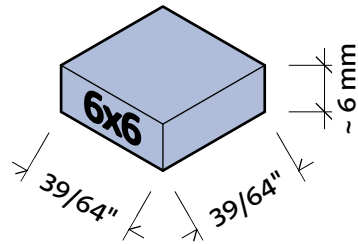

6" x 6" Ledge Rock paver.  
Just cut a 6x9 to size. Always shown in light blue.

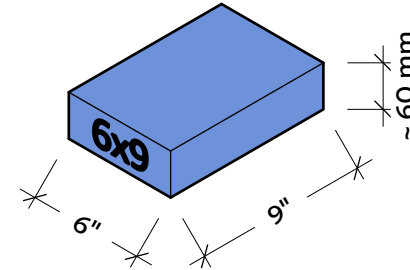

6" x 9" Ledge Rock paver.  
Great to use as a small cap. Always shown in medium blue.

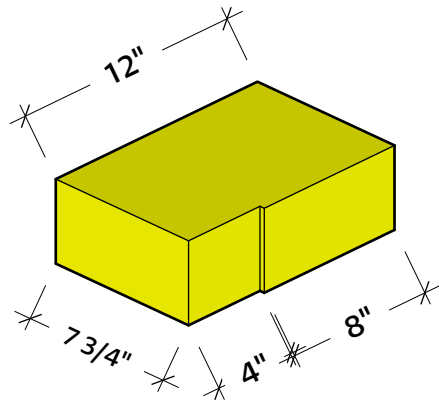

Lintel Block. You will need to cut four (4) of these precisely. The depth of the cut should match the thickness of your angle iron.

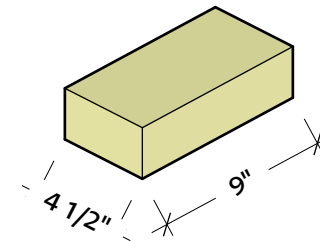

Fire brick. These hard refractory brick are very dense. Use them to line your firebox. You will need to cut a few to fit.

When constructing your project, be sure to keep all blocks level, square, and plumb. Use a four foot level and check often. Starting on a level foundation is key. When gluing blocks together, be sure not to use too much adhesive - this will cause the blocks to "swim." A small bead is ideal.

Dakota Stone™

**BUILD WITH  
DAKOTA**

**FPD-5228**

See-Thru Fireplace

REVISIONS

	MM/DD/YY	REMARKS
1	06/04/15	2 SKU and QR update
2	--/--/--	...
3	--/--/--	...
4	--/--/--	...
5	--/--/--	...

**KEY2**

This is your foundation block. One cannot over emphasize the importance of properly installing this layer. **Be sure to take the time to ensure it is "perfectly" square and level.** Any imperfections here will continue to show up over and over as you build this kit.

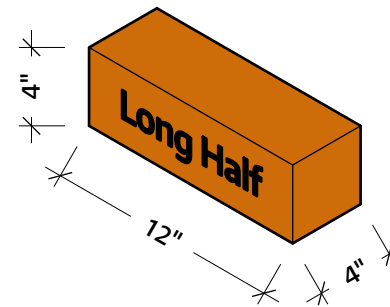
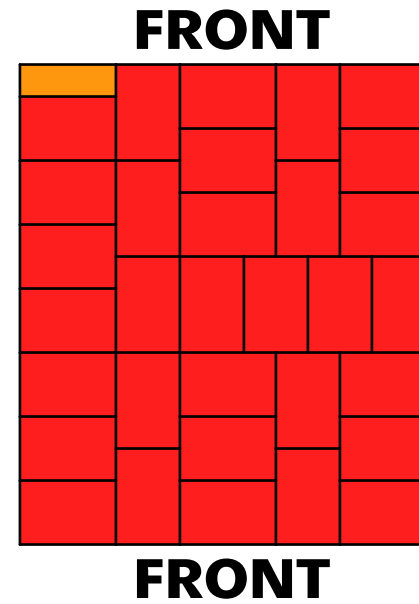
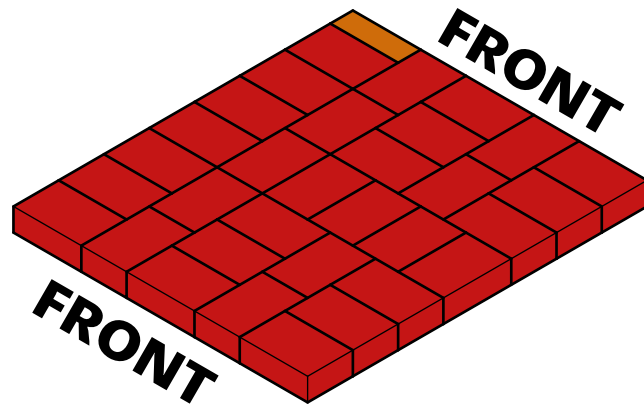

Long Halfs are simply made by cutting a block along its center on the longest axis.

When constructing your project, be sure to keep all blocks level, square, and plumb. Use a four foot level and check often. Starting on a level foundation is key. When gluing blocks together, be sure not to use too much adhesive - this will cause the blocks to "swim." A small bead is ideal.

Dakota Stone™

**BUILD WITH  
DAKOTA**

**FPD-5228**

See-Thru Fireplace

REVISIONS

	MM/DD/YY	REMARKS
1	06/04/15	2 SKU and QR update
2	--/--/--	...
3	--/--/--	...
4	--/--/--	...
5	--/--/--	...

**01**

This is your foundation block. One cannot over emphasize the importance of properly installing this layer. **Be sure to take the time to ensure it is "perfectly" square and level.** Any imperfections here will continue to show up over and over as you build this kit.

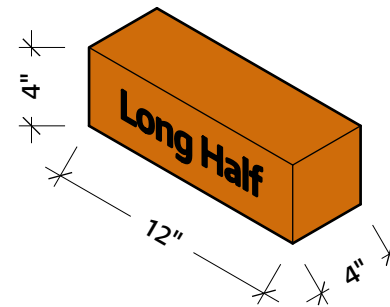
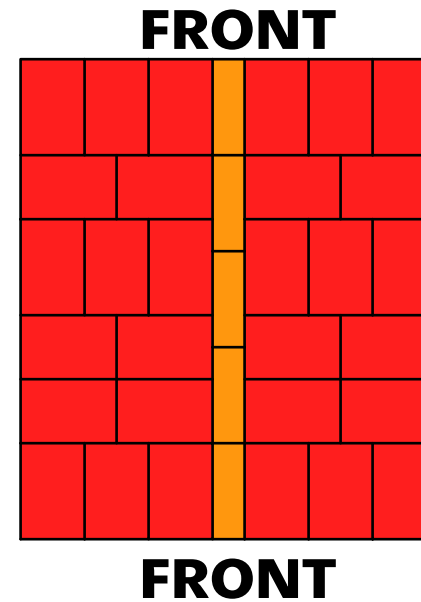
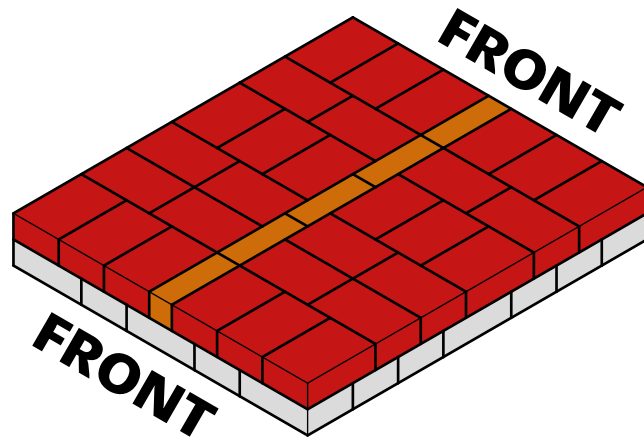

Long Halfs are simply made by cutting a block along its center by cutting a block along its center on the longest axis.

When constructing your project, be sure to keep all blocks level, square, and plumb. Use a four foot level and check often. Starting on a level foundation is key. When gluing blocks together, be sure not to use too much adhesive - this will cause the blocks to "swim." A small bead is ideal.

Dakota Stone™

**BUILD WITH  
DAKOTA**

**FPD-5228**

See-Thru Fireplace

REVISIONS

	MM/DD/YY	REMARKS
1	06/04/15	2 SKU and QR update
2	--/--/--	...
3	--/--/--	...
4	--/--/--	...
5	--/--/--	...

**02**

Always start building from the outside corners. This will help ensure you keep your structure plumb.

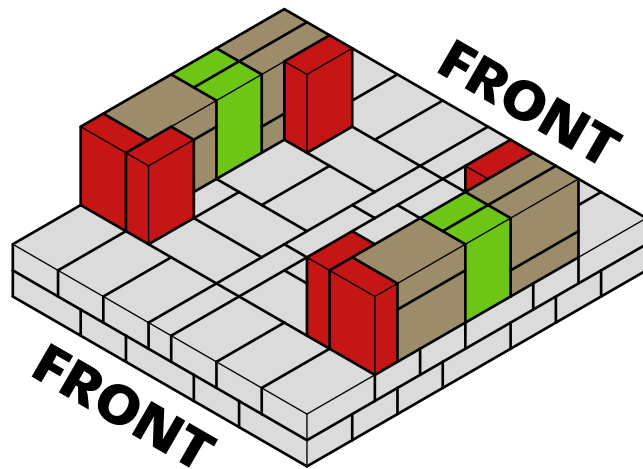

## TOP

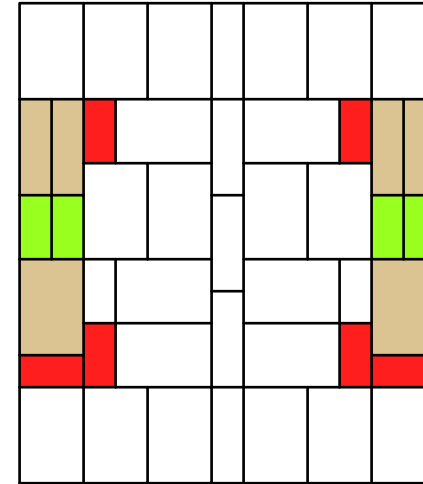

Any time you see a block with just the wide top showing, fret not, it is a Square Foot Unit (SFU). The unit is just turned where the that is the only block you see.

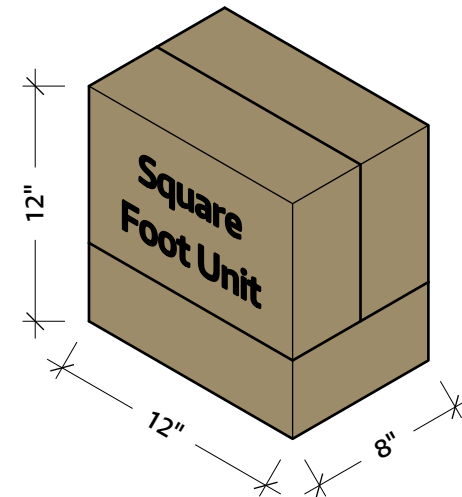

When constructing your project, be sure to keep all blocks level, square, and plumb. Use a four foot level and check often. Starting on a level foundation is key. When gluing blocks together, be sure not to use too much adhesive - this will cause the blocks to "swim." A small bead is ideal.

**Dakota Stone™**

**BUILD WITH  
DAKOTA**

**FPD-5228**

See-Thru Fireplace

### REVISIONS

	MM/DD/YY	REMARKS
1	06/04/15	2 SKU and QR update
2	--/--/--	...
3	--/--/--	...
4	--/--/--	...
5	--/--/--	...

**03**



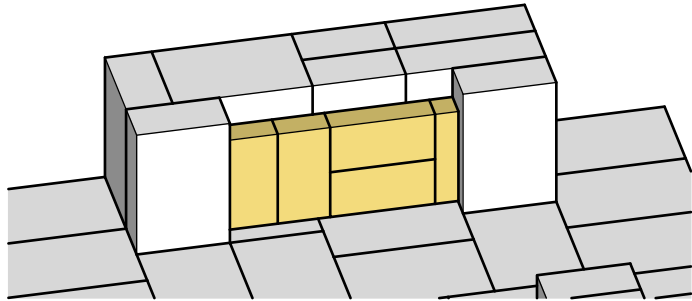

When facing each side, start with a full fire brick at the left. Cut the final fire brick to fit.

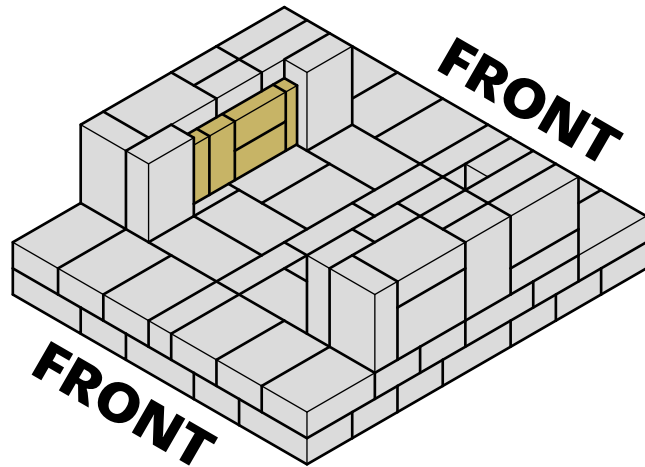

**TOP**

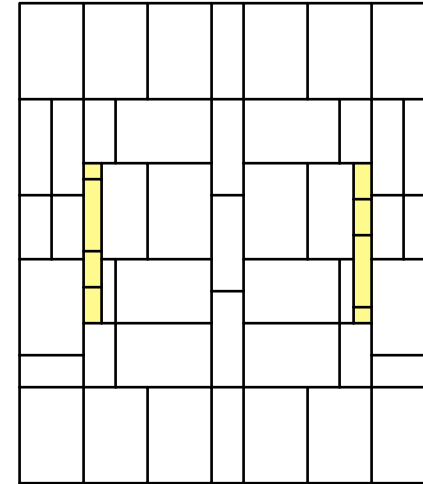

When constructing your project, be sure to keep all blocks level, square, and plumb. Use a four foot level and check often. Starting on a level foundation is key. When gluing blocks together, be sure not to use too much adhesive - this will cause the blocks to "swim." A small bead is ideal.

**Dakota Stone™**

**BUILD WITH  
DAKOTA**

**FPD-5228**

See-Thru Fireplace

REVISIONS

	MM/DD/YY	REMARKS
1	06/04/15	2 SKU and QR update
2	--/--/--	...
3	--/--/--	...
4	--/--/--	...
5	--/--/--	...

**04**



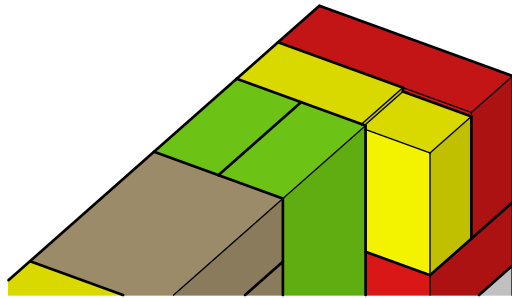

Cut the notch on your lintel block all the way through and 4" wide as shown.

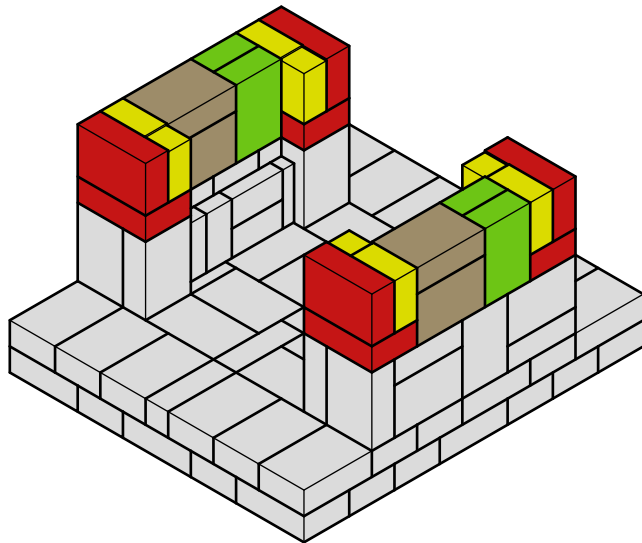

## TOP

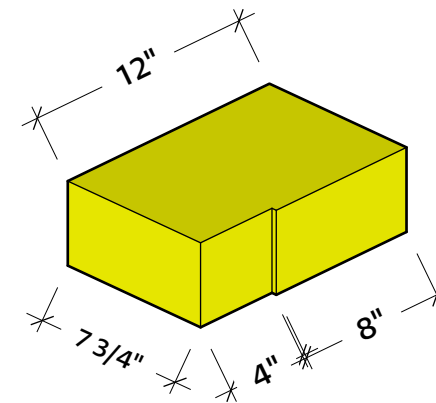
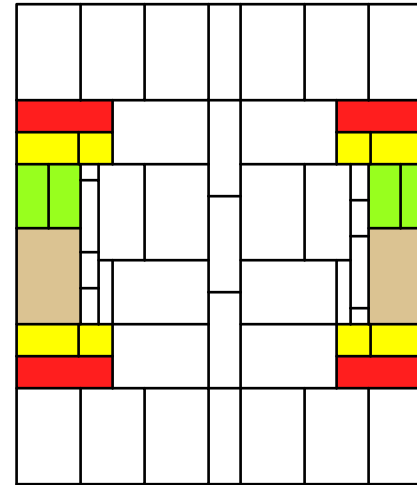

Lintel Block. You will need to cut four (4) of these precisely. The depth of the cut should match the thickness of your angle iron.

When constructing your project, be sure to keep all blocks level, square, and plumb. Use a four foot level and check often. Starting on a level foundation is key. When gluing blocks together, be sure not to use too much adhesive - this will cause the blocks to "swim." A small bead is ideal.

Dakota Stone™

**BUILD WITH  
DAKOTA**

**FPD-5228**

See-Thru Fireplace

### REVISIONS

	MM/DD/YY	REMARKS
1	06/04/15	2 SKU and QR update
2	--/--/--	...
3	--/--/--	...
4	--/--/--	...
5	--/--/--	...

**05**

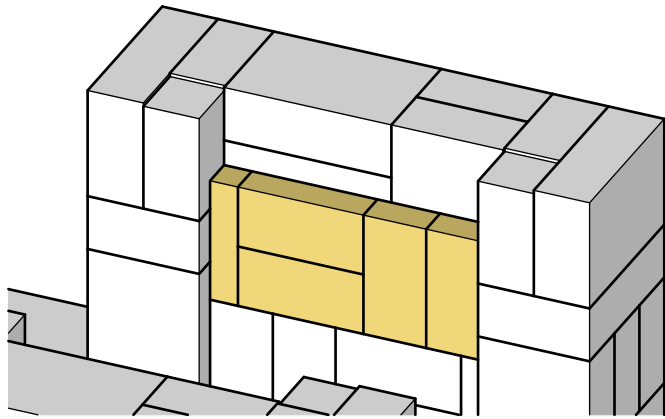

When facing each side, start with a full fire brick at the right. Cut the final fire brick to fit.

## TOP

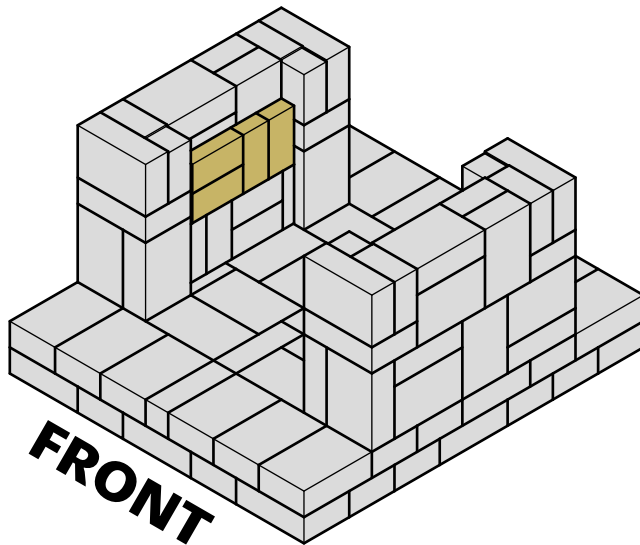
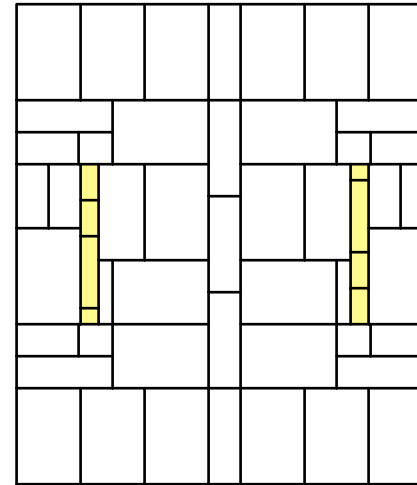

**FRONT**

When constructing your project, be sure to keep all blocks level, square, and plumb. Use a four foot level and check often. Starting on a level foundation is key. When gluing blocks together, be sure not to use too much adhesive - this will cause the blocks to "swim." A small bead is ideal.

**Dakota Stone™**

**BUILD WITH  
DAKOTA**

**FPD-5228**

See-Thru Fireplace

### REVISIONS

	MM/DD/YY	REMARKS
1	06/04/15	2 SKU and QR update
2	--/--/--	...
3	--/--/--	...
4	--/--/--	...
5	--/--/--	...

**06**

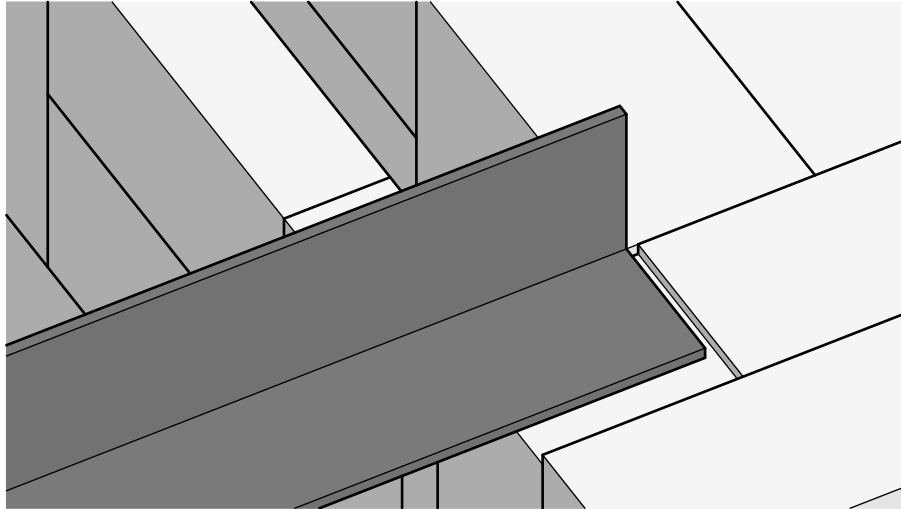

**TOP**

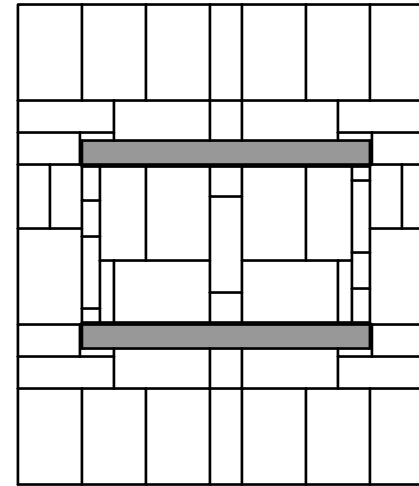

When constructing your project, be sure to keep all blocks level, square, and plumb. Use a four foot level and check often. Starting on a level foundation is key. When gluing blocks together, be sure not to use too much adhesive - this will cause the blocks to "swim." A small bead is ideal.

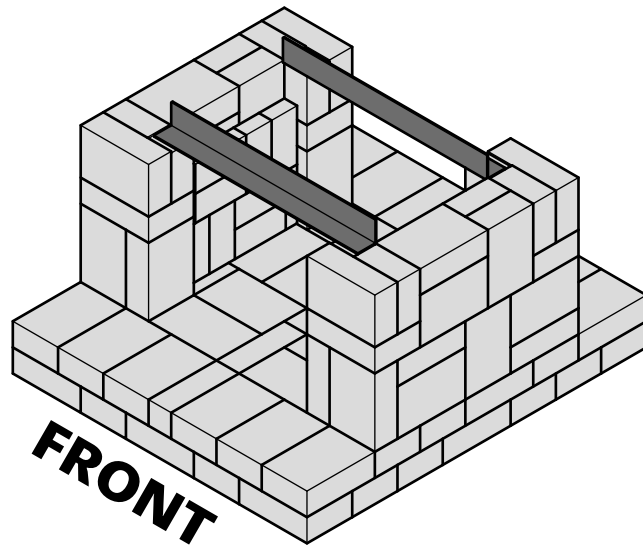

Place the angle iron such that the top of the angle leg is flush with the top of the lintel blocks. You may need to use coins as shims or add sand under the angle iron to make it flush. Be sure to roughly center the iron to the fire box opening. There will be extra room to allow for the angle iron to expand.

**Dakota Stone™**

**BUILD WITH  
DAKOTA**

**FPD-5228**

See-Thru Fireplace

REVISIONS

	MM/DD/YY	REMARKS
1	06/04/15	2 SKU and QR update
2	--/--/--	...
3	--/--/--	...
4	--/--/--	...
5	--/--/--	...

**07**

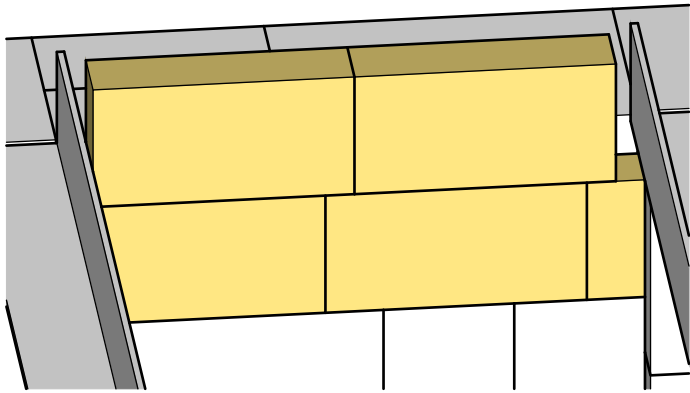

When facing each side, start with a full fire brick at the left. Cut the final fire brick to fit. Center the top two bricks between the irons.

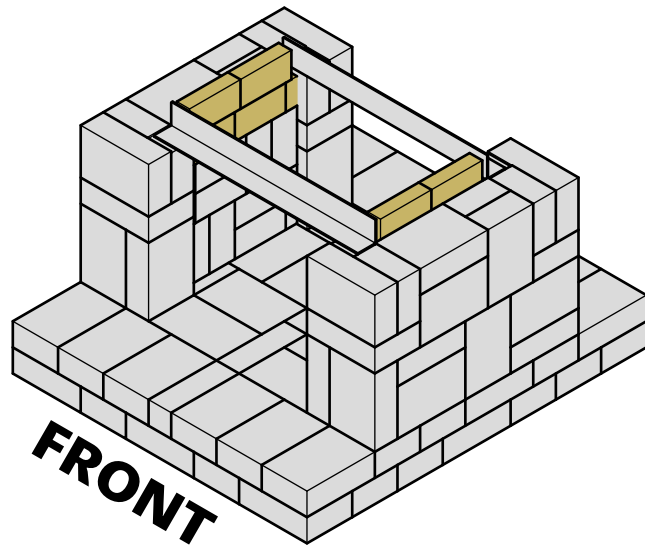

**TOP**

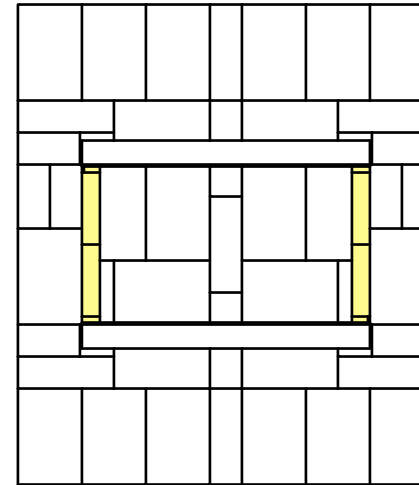

When constructing your project, be sure to keep all blocks level, square, and plumb. Use a four foot level and check often. Starting on a level foundation is key. When gluing blocks together, be sure not to use too much adhesive - this will cause the blocks to "swim." A small bead is ideal.

**Dakota Stone™**

**BUILD WITH  
DAKOTA**

**FPD-5228**

See-Thru Fireplace

REVISIONS

	MM/DD/YY	REMARKS
1	06/04/15	2 SKU and QR update
2	--/--/--	...
3	--/--/--	...
4	--/--/--	...
5	--/--/--	...

**08**

You will need to set up TEMPORARY support blocks before proceeding to the next step.

**DO NOT GLUE THESE SUPPORT BLOCKS!**

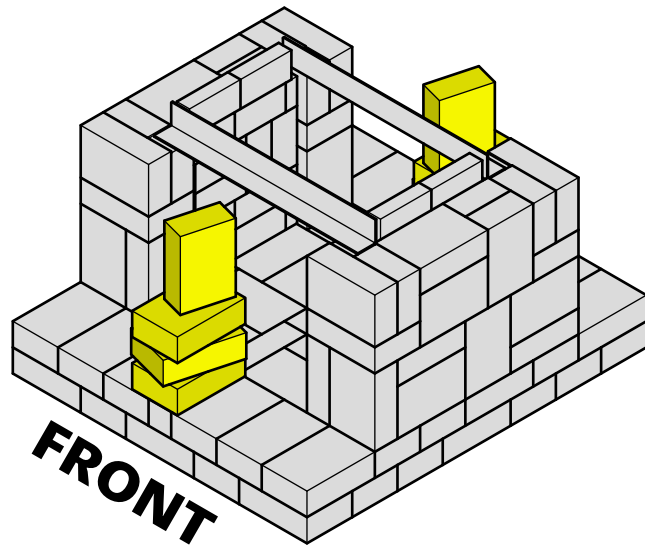

**TOP**

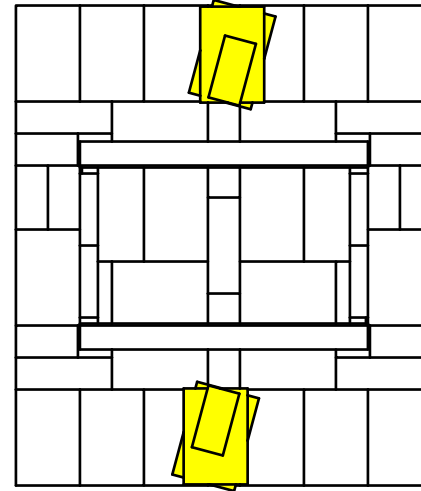

When constructing your project, be sure to keep all blocks level, square, and plumb. Use a four foot level and check often. Starting on a level foundation is key. When gluing blocks together, be sure not to use too much adhesive - this will cause the blocks to "swim." A small bead is ideal.

**Dakota Stone™**

**BUILD WITH  
DAKOTA**

**FPD-5228**

See-Thru Fireplace

REVISIONS

	MM/DD/YY	REMARKS
1	06/04/15	2 SKU and QR update
2	--/--/--	...
3	--/--/--	...
4	--/--/--	...
5	--/--/--	...

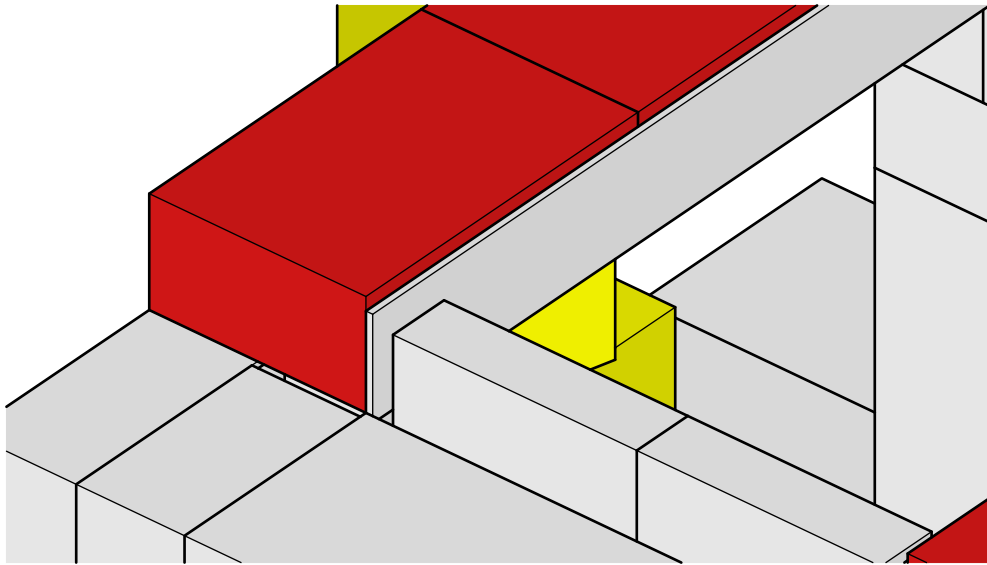

Be sure the front of the block are flush to your firebox. They should be pushed snug against the angle iron. You may need to reposition the iron for proper fit.

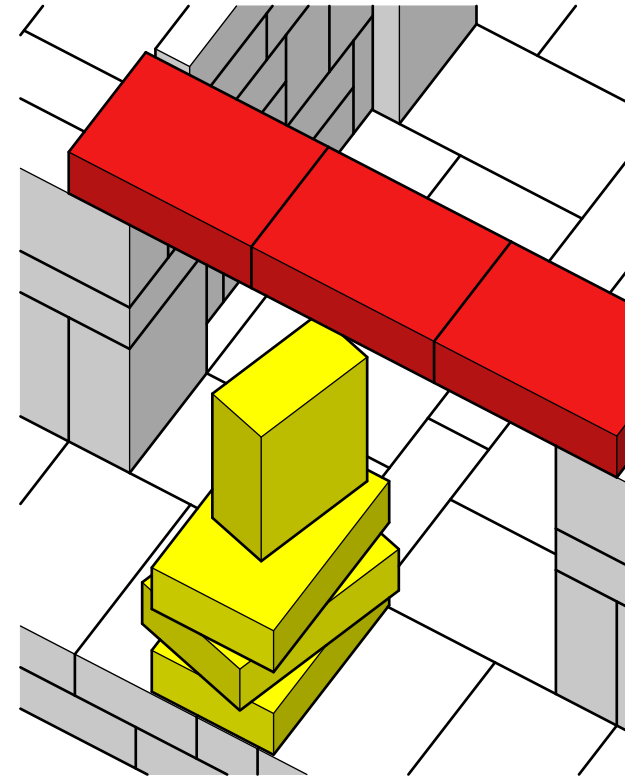
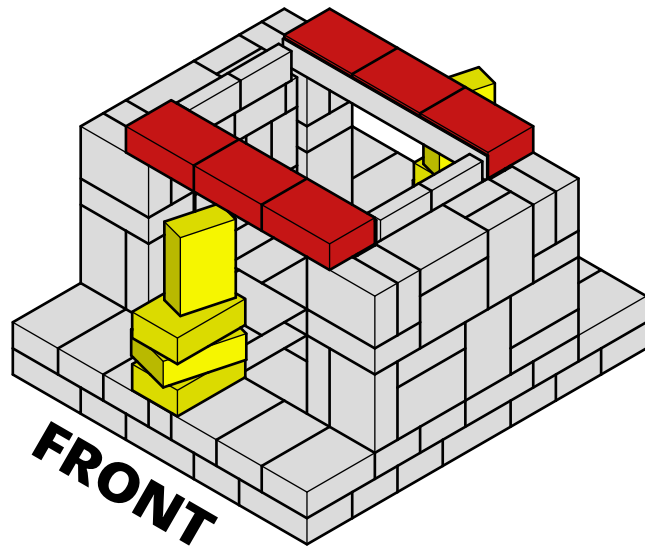

Just use the corner to catch the middle block.

When constructing your project, be sure to keep all blocks level, square, and plumb. Use a four foot level and check often. Starting on a level foundation is key. When gluing blocks together, be sure not to use too much adhesive - this will cause the blocks to "swim." A small bead is ideal.

Dakota Stone™

**BUILD WITH  
DAKOTA**

**FPD-5228**

See-Thru Fireplace

REVISIONS

	MM/DD/YY	REMARKS
1	06/04/15	2 SKU and QR update
2	--/--/--	...
3	--/--/--	...
4	--/--/--	...
5	--/--/--	...

You will need to set up TEMPORARY support blocks before proceeding to the next step.

**DO NOT GLUE THESE SUPPORT BLOCKS!**

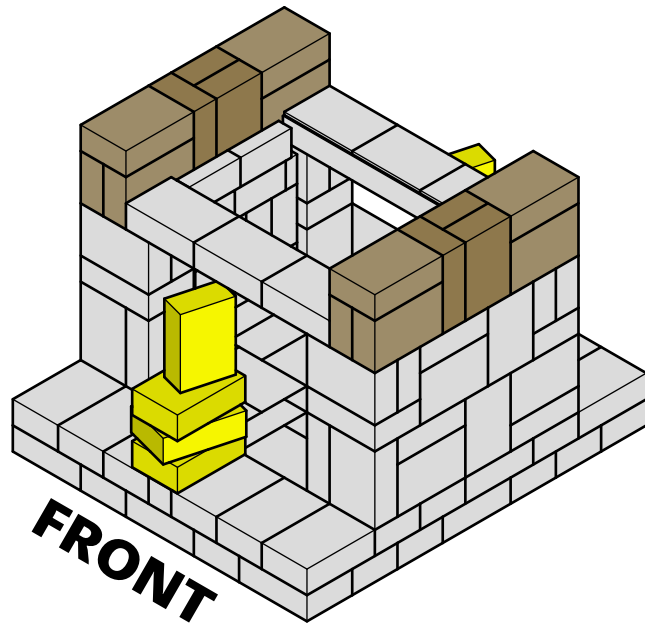

**TOP**

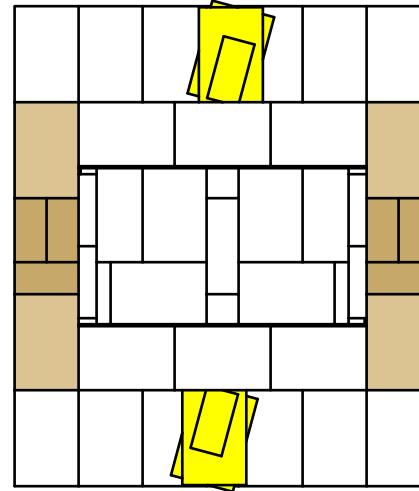

When constructing your project, be sure to keep all blocks level, square, and plumb. Use a four foot level and check often. Starting on a level foundation is key. When gluing blocks together, be sure not to use too much adhesive - this will cause the blocks to "swim." A small bead is ideal.

**Dakota Stone™**

**BUILD WITH  
DAKOTA**

**FPD-5228**

See-Thru Fireplace

REVISIONS

	MM/DD/YY	REMARKS
1	06/04/15	2 SKU and QR update
2	--/--/--	...
3	--/--/--	...
4	--/--/--	...
5	--/--/--	...



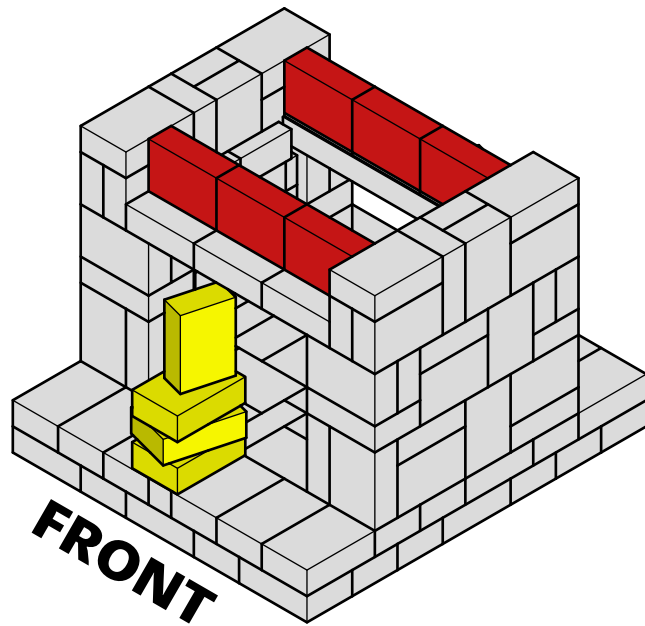

**TOP**

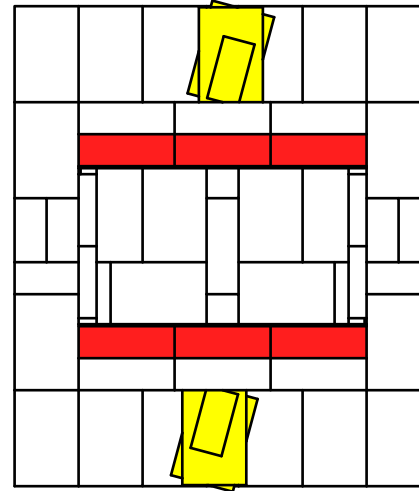

When constructing your project, be sure to keep all blocks level, square, and plumb. Use a four foot level and check often. Starting on a level foundation is key. When gluing blocks together, be sure not to use too much adhesive - this will cause the blocks to "swim." A small bead is ideal.

**Dakota Stone™**

**BUILD WITH  
DAKOTA**

**FPD-5228**

See-Thru Fireplace

REVISIONS

	MM/DD/YY	REMARKS
1	06/04/15	2 SKU and QR update
2	--/--/--	...
3	--/--/--	...
4	--/--/--	...
5	--/--/--	...

**12**

## 6x8x4 Half Block

You will need to cut two Euro block in half.  
This will get you four Half Block. These are used to stagger the bond lines above the lintel.

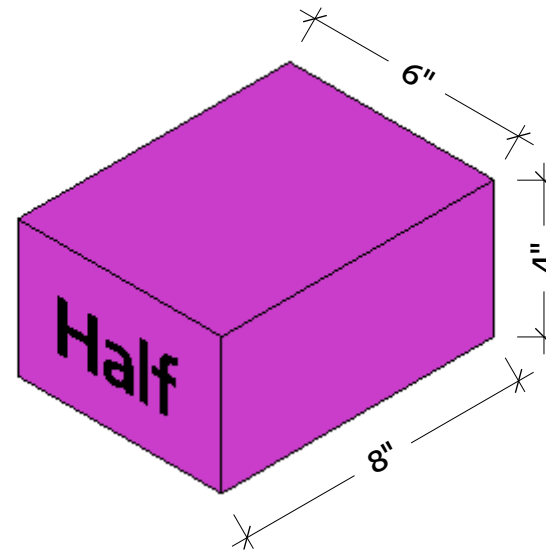
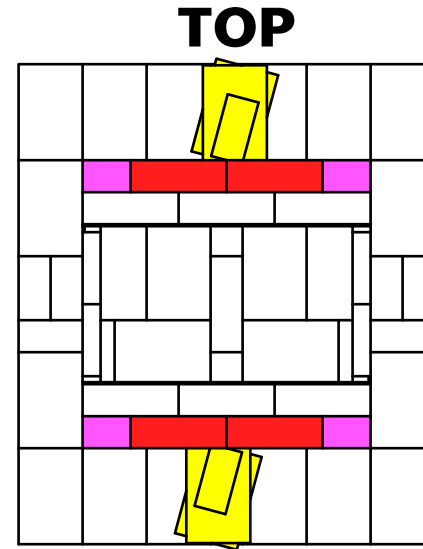
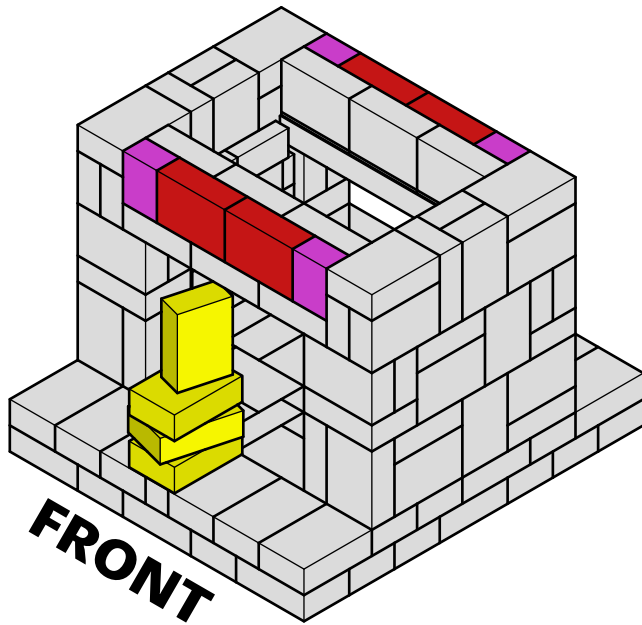

When constructing your project, be sure to keep all blocks level, square, and plumb. Use a four foot level and check often. Starting on a level foundation is key. When gluing blocks together, be sure not to use too much adhesive - this will cause the blocks to "swim." A small bead is ideal.

Dakota Stone™

**BUILD WITH  
DAKOTA**

**FPD-5228**

See-Thru Fireplace

### REVISIONS

	MM/DD/YY	REMARKS
1	06/04/15	2 SKU and QR update
2	--/--/--	...
3	--/--/--	...
4	--/--/--	...
5	--/--/--	...

**13**

This is the first set-back when making the throat of the chimney. This is the most important one. The following courses are built off this one. Be sure to center this course. There should be about a 2" inset from all sides of the previous course.

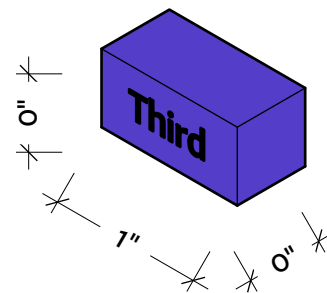
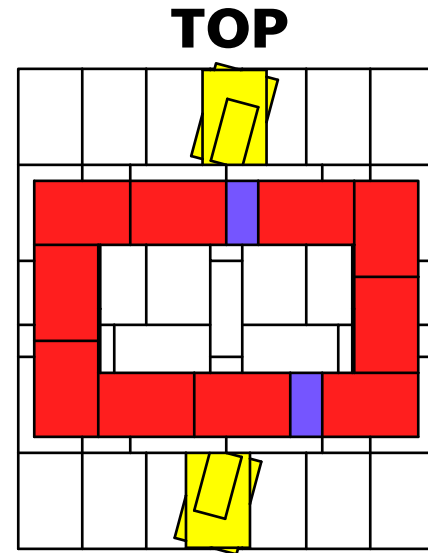
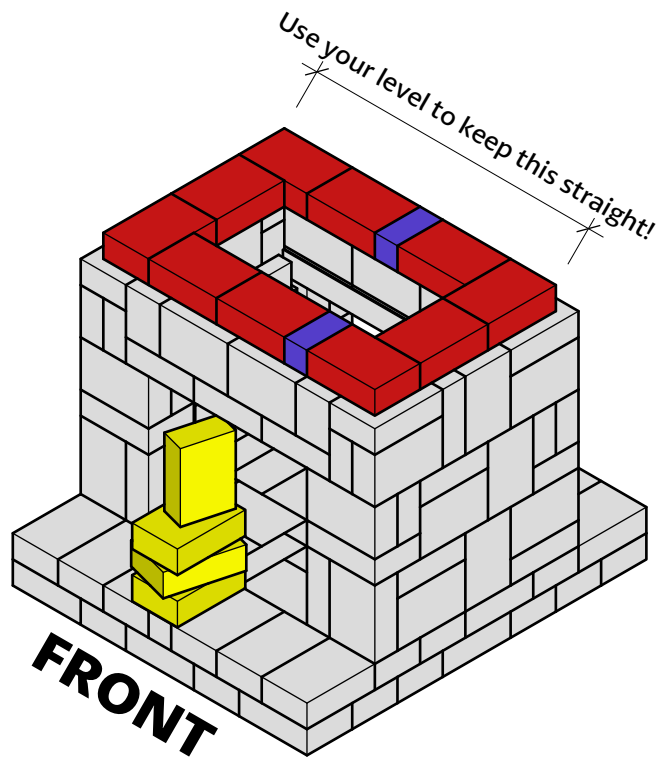

Cutting four inches off the short end of a Euro block will get you a Third block (and a Square one).

When constructing your project, be sure to keep all blocks level, square, and plumb. Use a four foot level and check often. Starting on a level foundation is key. When gluing blocks together, be sure not to use too much adhesive - this will cause the blocks to "swim." A small bead is ideal.

Dakota Stone™

**BUILD WITH  
DAKOTA**

**FPD-5228**

See-Thru Fireplace

REVISIONS

	MM/DD/YY	REMARKS
1	06/04/15	2 SKU and QR update
2	--/--/--	...
3	--/--/--	...
4	--/--/--	...
5	--/--/--	...

14

This course is flush on the two facing sides. Only the sides will rack in about 2" on each side.

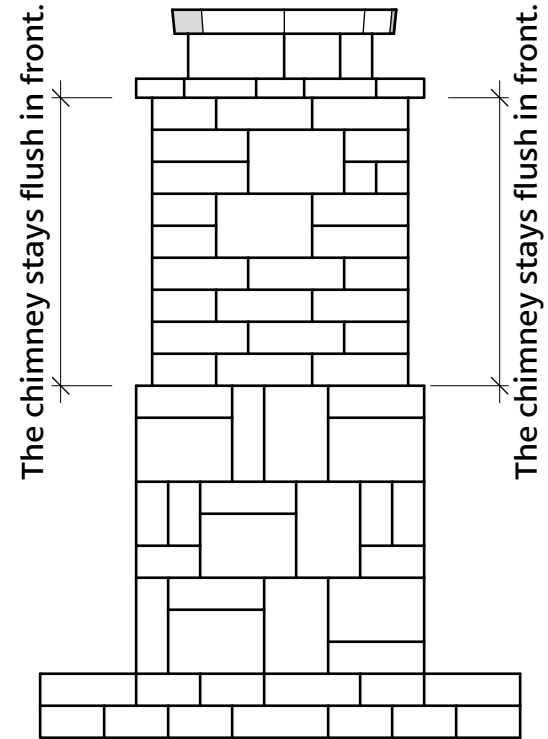
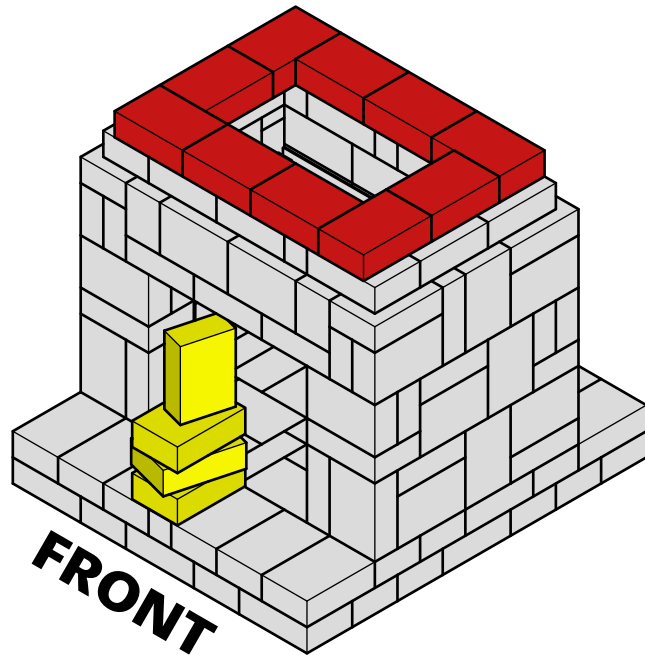

**RIGHT**

When constructing your project, be sure to keep all blocks level, square, and plumb. Use a four foot level and check often. Starting on a level foundation is key. When gluing blocks together, be sure not to use too much adhesive - this will cause the blocks to "swim." A small bead is ideal.

**Dakota Stone™**

**BUILD WITH  
DAKOTA**

**FPD-5228**

See-Thru Fireplace

REVISIONS

	MM/DD/YY	REMARKS
1	06/04/15	2 SKU and QR update
2	--/--/--	..
3	--/--/--	..
4	--/--/--	..
5	--/--/--	..

This course is flush on the two facing sides. Only the sides will rack in about 2" on each side.

Remove your support blocks from step 14.

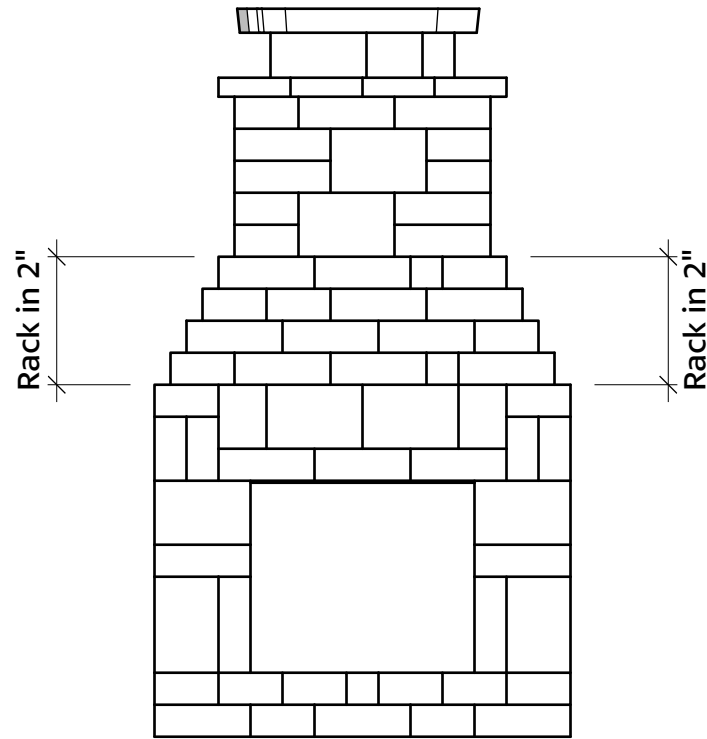
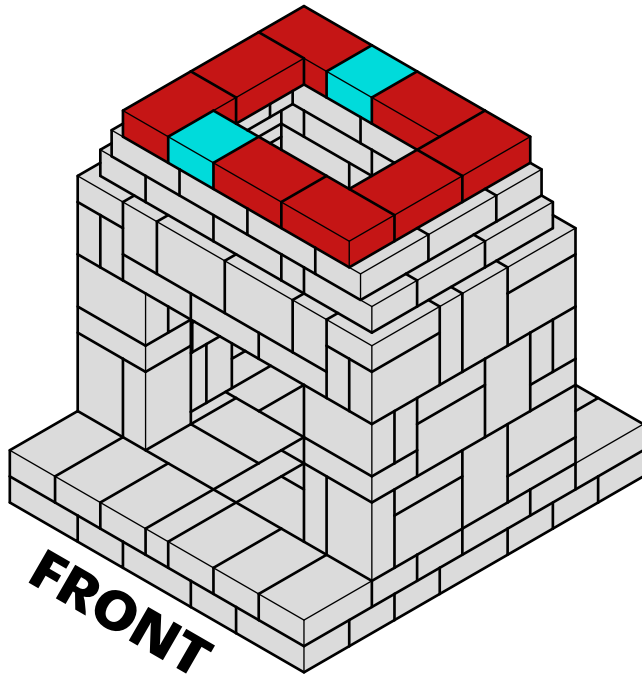

**FRONT**

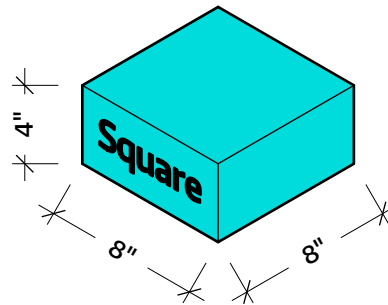

Cutting four inches off the short end of a Dakota Stone™ will get you a Square block (and a Third one).

When constructing your project, be sure to keep all blocks level, square, and plumb. Use a four foot level and check often. Starting on a level foundation is key. When gluing blocks together, be sure not to use too much adhesive - this will cause the blocks to "swim." A small bead is ideal.

**Dakota Stone™**

**BUILD WITH  
DAKOTA**

**FPD-5228**

See-Thru Fireplace

REVISIONS

	MM/DD/YY	REMARKS
1	06/04/15	2 SKU and QR update
2	---/---/---	...
3	---/---/---	...
4	---/---/---	...
5	---/---/---	...

**16**

This course is flush on the two facing sides. Only the sides will rack in about 2" on each side.

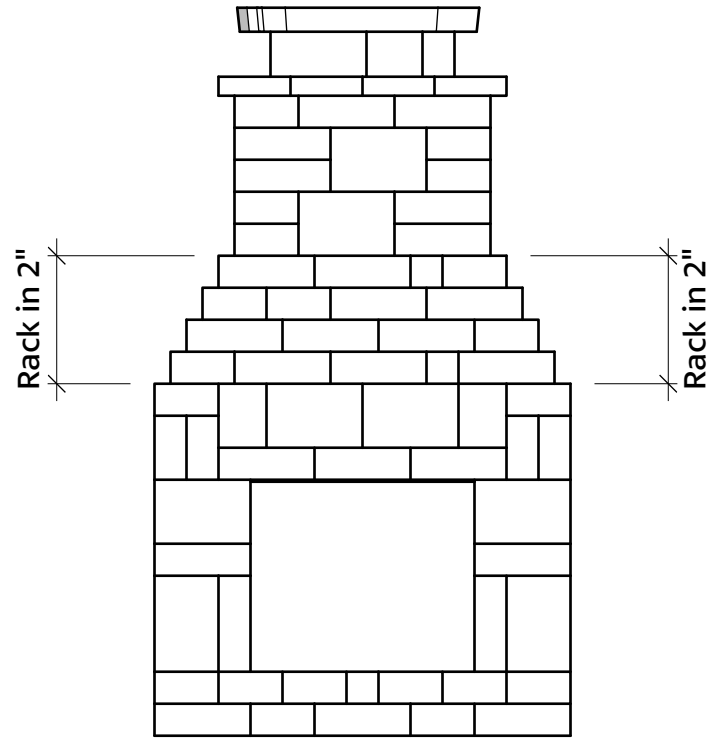
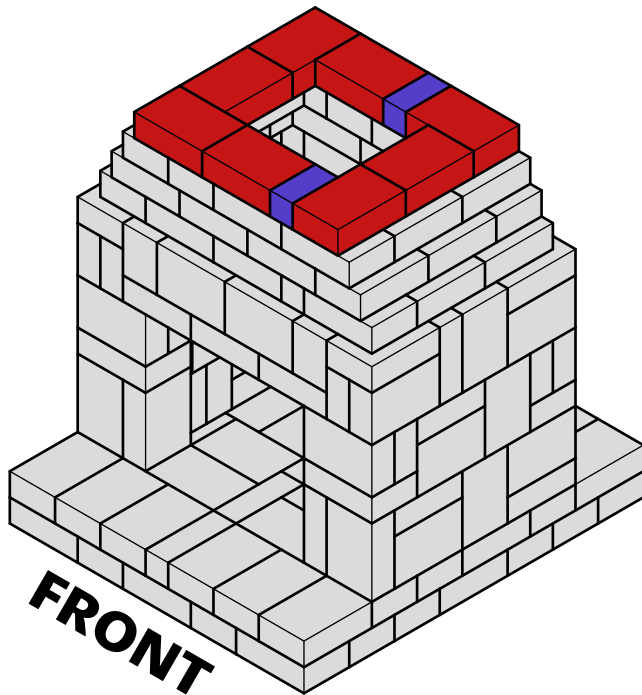

**FRONT**

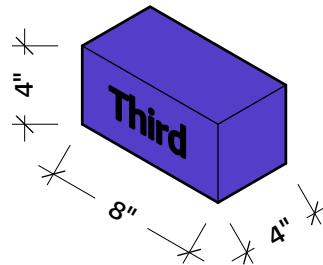

Cutting four inches off the short end of a Dakota Stone™ will get you a Third block (and a Square one).

When constructing your project, be sure to keep all blocks level, square, and plumb. Use a four foot level and check often. Starting on a level foundation is key. When gluing blocks together, be sure not to use too much adhesive - this will cause the blocks to "swim." A small bead is ideal.

**Dakota Stone™**

**BUILD WITH  
DAKOTA**

**FPD-5228**

See-Thru Fireplace

REVISIONS

	MM/DD/YY	REMARKS
1	06/04/15	2 SKU and QR update
2	---/---/---	...
3	---/---/---	...
4	---/---/---	...
5	---/---/---	...

This course is flush on the two facing sides. Only the sides will rack in about 2" on each side.

Remove your support blocks from step 14.

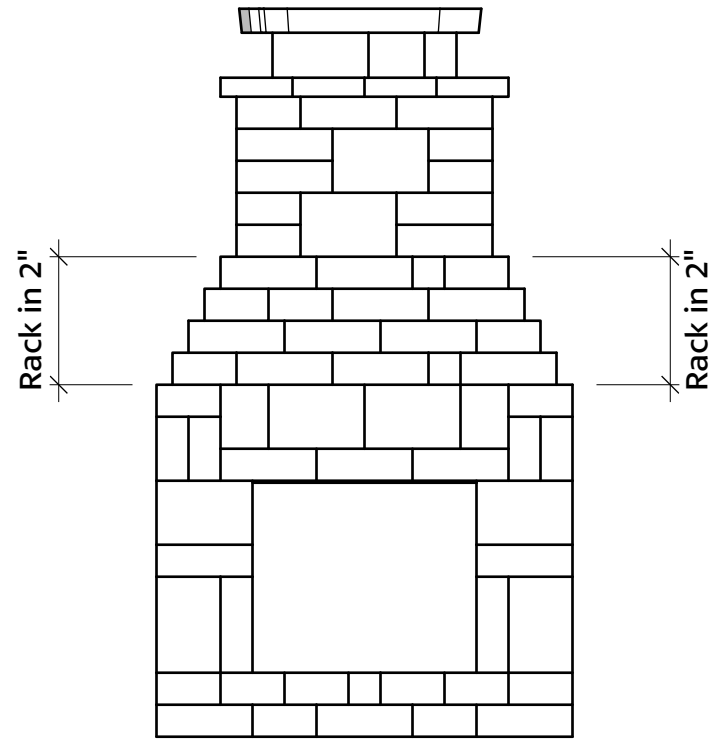
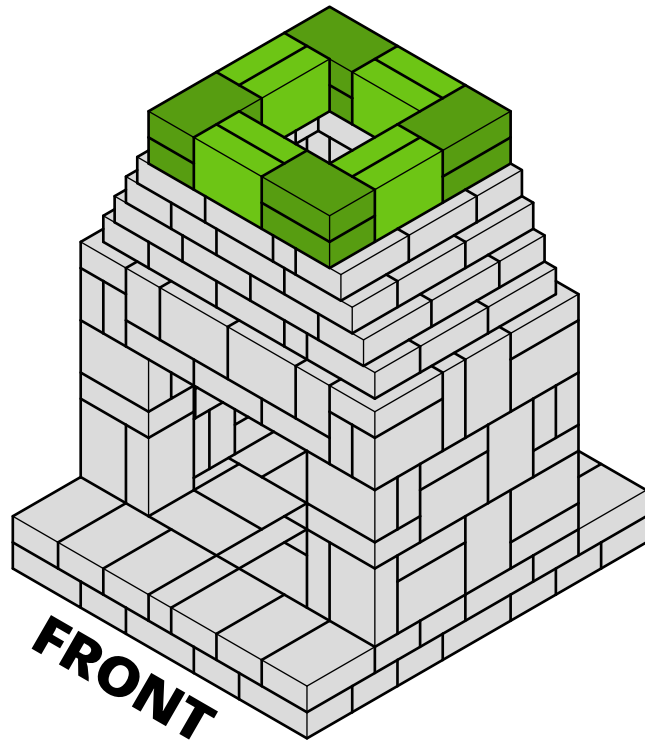

**FRONT**

When constructing your project, be sure to keep all blocks level, square, and plumb. Use a four foot level and check often. Starting on a level foundation is key. When gluing blocks together, be sure not to use too much adhesive - this will cause the blocks to "swim." A small bead is ideal.

**Dakota Stone™**

**BUILD WITH  
DAKOTA**

**FPD-5228**

See-Thru Fireplace

REVISIONS

	MM/DD/YY	REMARKS
1	06/04/15	2 SKU and QR update
2	--/--/--	...
3	--/--/--	...
4	--/--/--	...
5	--/--/--	...

**18**



This course does not rack in.

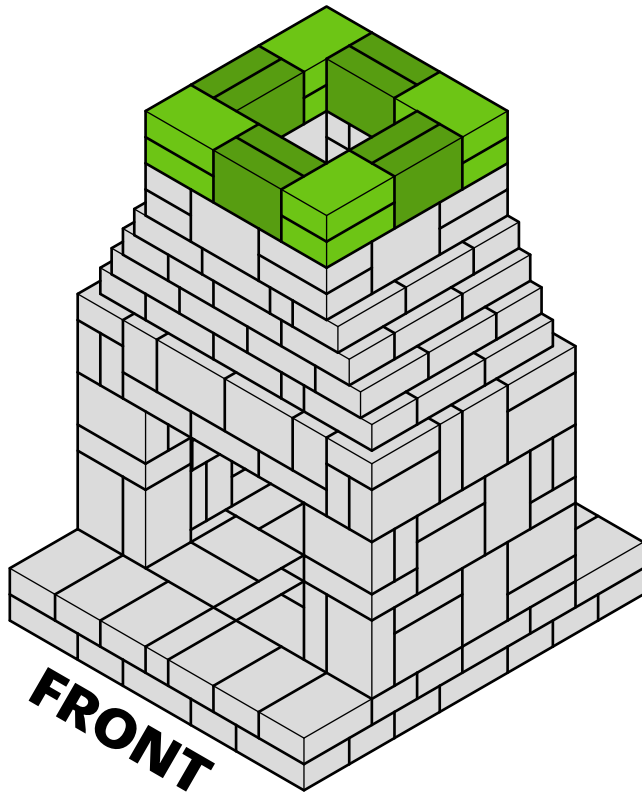

**TOP**

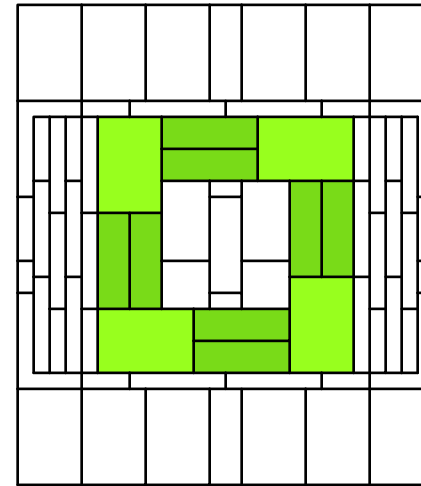

When constructing your project, be sure to keep all blocks level, square, and plumb. Use a four foot level and check often. Starting on a level foundation is key. When gluing blocks together, be sure not to use too much adhesive - this will cause the blocks to "swim." A small bead is ideal.

**Dakota Stone™**

**BUILD WITH  
DAKOTA**

**FPD-5228**

See-Thru Fireplace

REVISIONS

	MM/DD/YY	REMARKS
1	06/04/15	2 SKU and QR update
2	--/--/--	...
3	--/--/--	...
4	--/--/--	...
5	--/--/--	...

This course does not rack in.

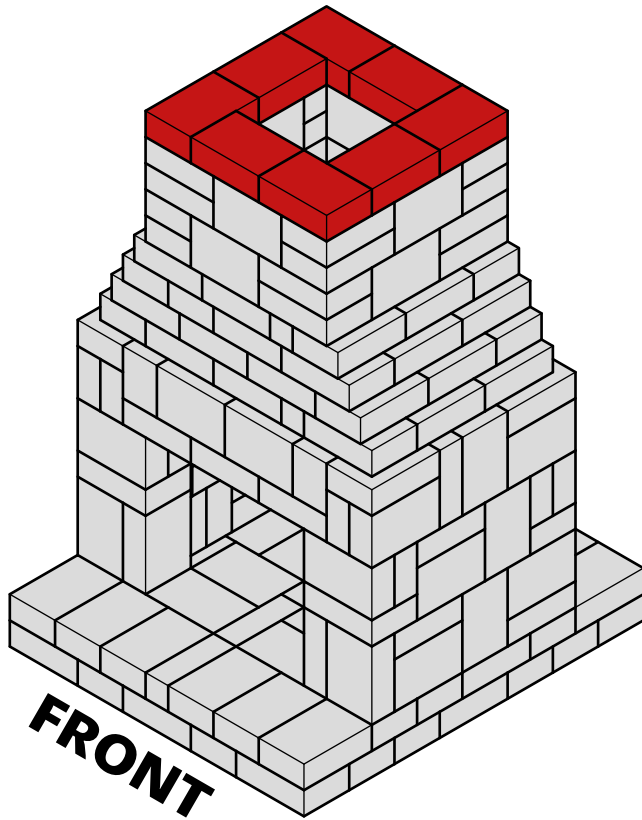

## TOP

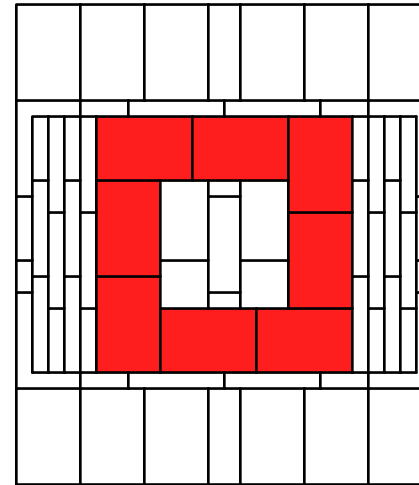

When constructing your project, be sure to keep all blocks level, square, and plumb. Use a four foot level and check often. Starting on a level foundation is key. When gluing blocks together, be sure not to use too much adhesive - this will cause the blocks to "swim." A small bead is ideal.

**Dakota Stone**<sup>TM</sup>

**BUILD WITH  
DAKOTA**

**FPD-5228**

See-Thru Fireplace

### REVISIONS

	MM/DD/YY	REMARKS
1	06/04/15	2 SKU and QR update
2	--/--/--	...
3	--/--/--	...
4	--/--/--	...
5	--/--/--	...

**20**

Before gluing the top four blocks in place, TEMPORARILY lay out your crown blocks (blue shades) to ensure you have them properly positioned. **DO NOT GLUE THE CROWN BLOCKS AT THIS TIME.** Only glue the four cap support blocks (depicted in red). You want to pull your support block in about 1/2" to allow extra room when squaring your cap later.

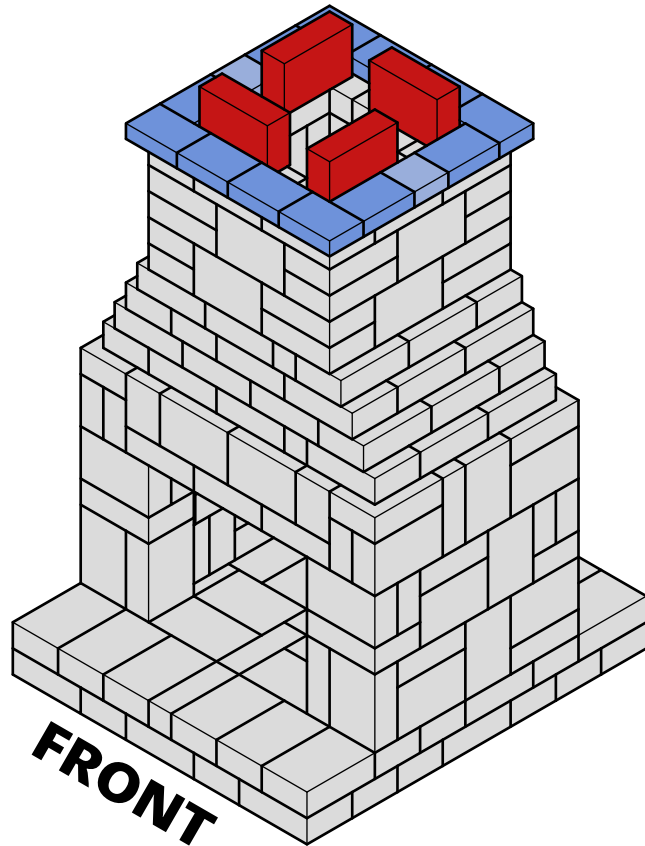

## TOP

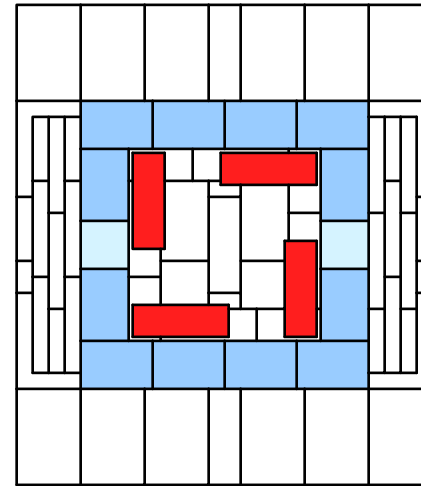

TEMPORARILY lay out your crown blocks to ensure you have them properly positioned.

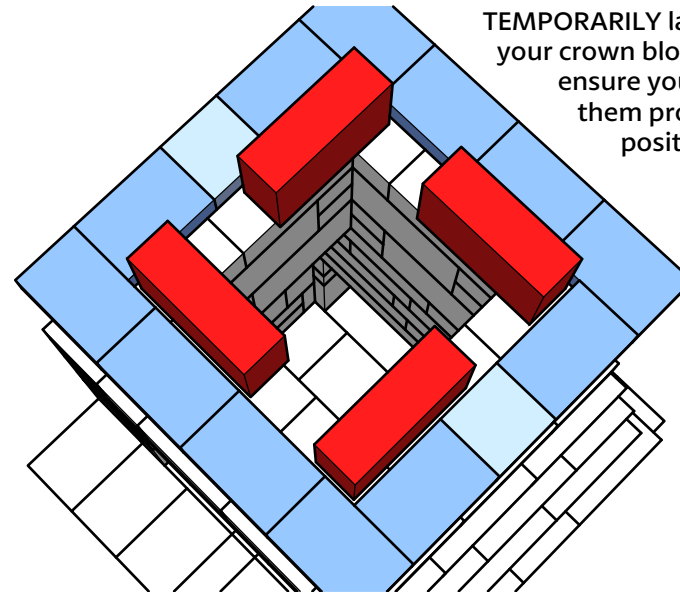

When constructing your project, be sure to keep all blocks level, square, and plumb. Use a four foot level and check often. Starting on a level foundation is key. When gluing blocks together, be sure not to use too much adhesive - this will cause the blocks to "swim." A small bead is ideal.

Dakota Stone™

**BUILD WITH  
DAKOTA**

**FPD-5228**

See-Thru Fireplace

### REVISIONS

	MM/DD/YY	REMARKS
1	06/04/15	2 SKU and QR update
2	--/--/--	...
3	--/--/--	...
4	--/--/--	...
5	--/--/--	...

**Remove the crown blocks before you install the large cap block.**

Allow the adhesive to fully cure before proceeding to lay the cap on these supports.

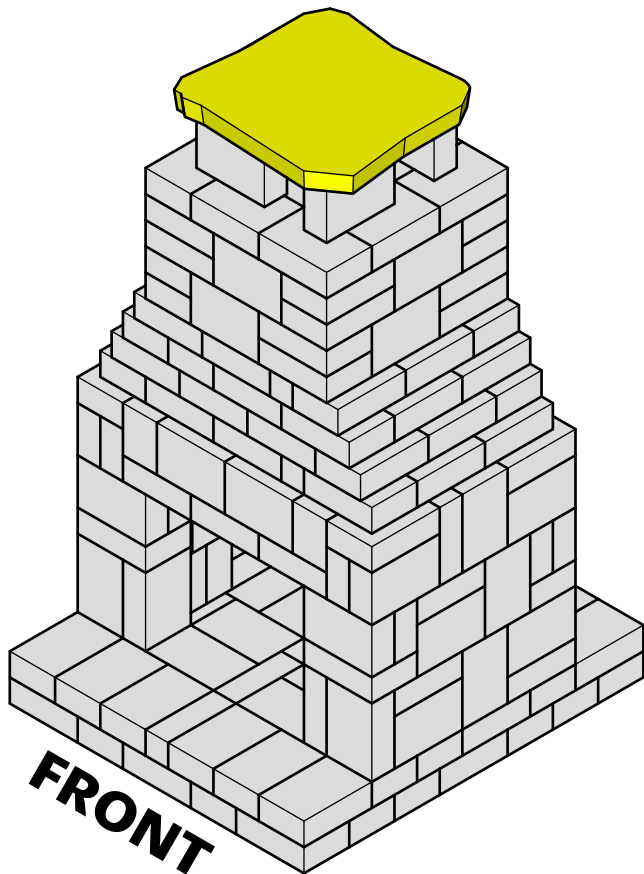

After the adhesive is set, place the cap block up-side-down on the top of your four block. Since the stone will be viewed from the ground looking up, the decorative side of the cap should be facing the ground. You may need to add some sand or coins to keep the cap from rocking on the block.

**Placing the cap is the hardest part of the entire build. Use ladders and/or scaffolding. You can use the ledges created by the raked block as a "strairway" to move the block up until the final heave.**

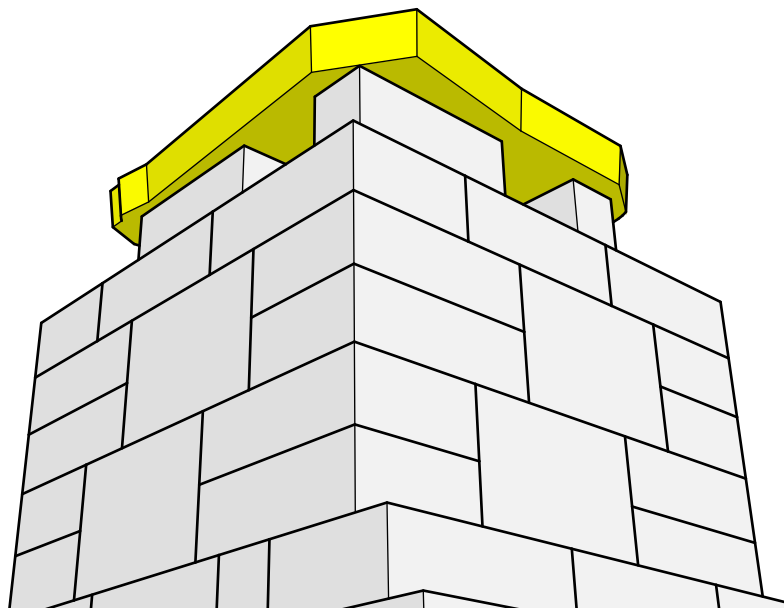

When constructing your project, be sure to keep all blocks level, square, and plumb. Use a four foot level and check often. Starting on a level foundation is key. When gluing blocks together, be sure not to use too much adhesive - this will cause the blocks to "swim." A small bead is ideal.

**Dakota Stone™**

**BUILD WITH  
DAKOTA**

**FPD-5228**

See-Thru Fireplace

REVISIONS

	MM/DD/YY	REMARKS
1	06/04/15	2 SKU and QR update
2	--/--/--	...
3	--/--/--	...
4	--/--/--	...
5	--/--/--	...

Add the finishing blocks. The back and sides of the crown are identical from one side to the other.  
Keep these finish pieces straight and square.

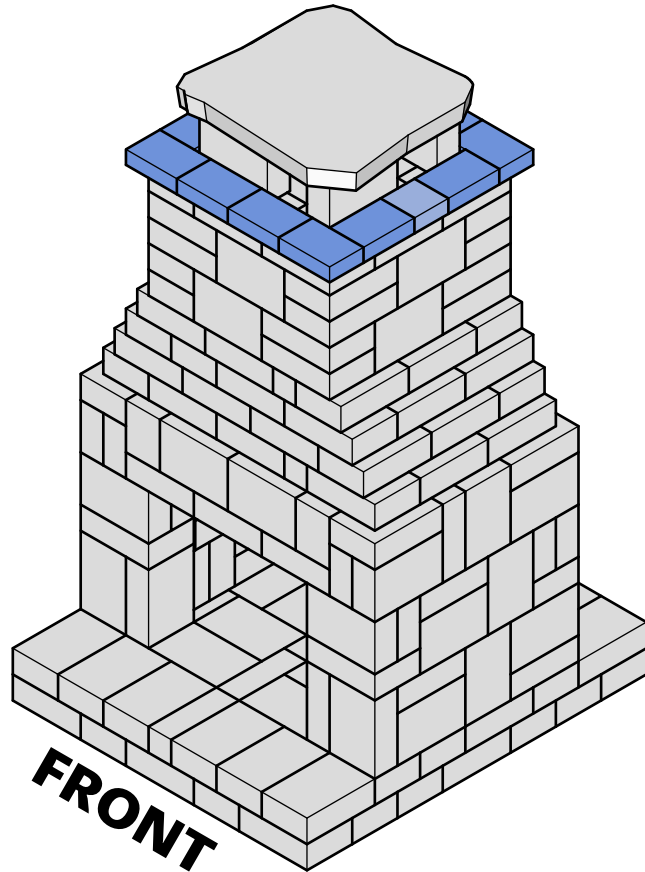

## TOP

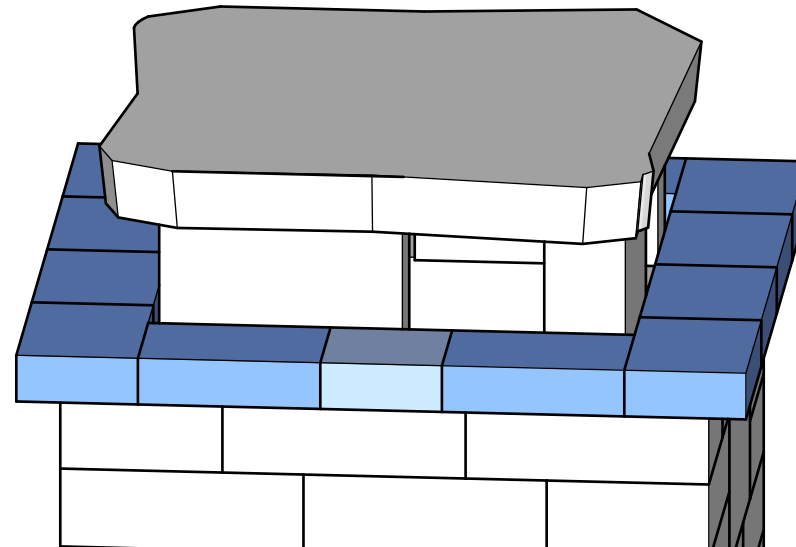
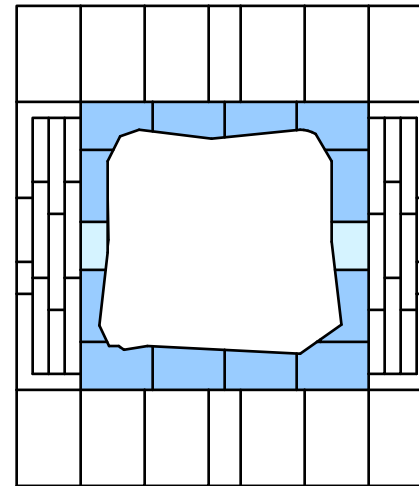

When constructing your project, be sure to keep all blocks level, square, and plumb. Use a four foot level and check often. Starting on a level foundation is key. When gluing blocks together, be sure not to use too much adhesive - this will cause the blocks to "swim." A small bead is ideal.

Dakota Stone™

**BUILD WITH  
DAKOTA**

**FPD-5228**

See-Thru Fireplace

### REVISIONS

	MM/DD/YY	REMARKS
1	06/04/15	2 SKU and QR update
2	--/--/--	...
3	--/--/--	...
4	--/--/--	...
5	--/--/--	...

**23**

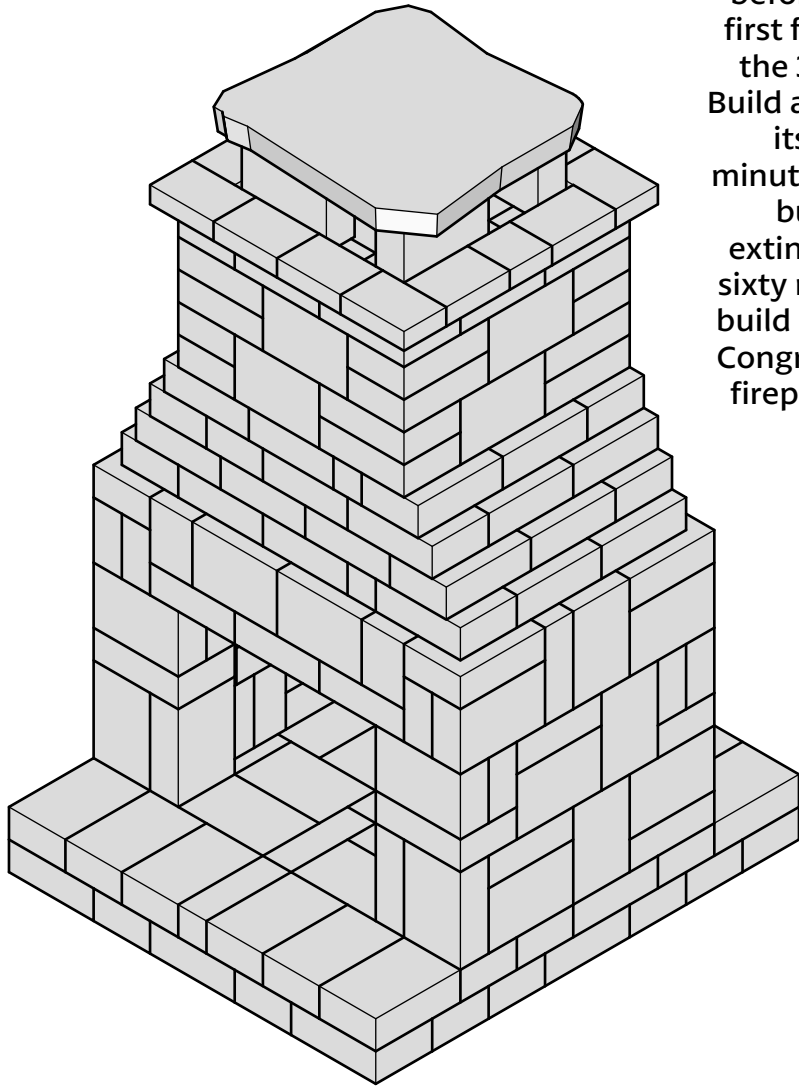

Allow the fireplace to cure for 72 hours before building your first fire. Then follow the 30/60/90 rule. Build a fire that will put itself out in 30 minutes. After it cools, build one that extinguishes itself in sixty minutes. Finally, build a 90 minute fire. Congratulations! Your fireplace is ready for use.

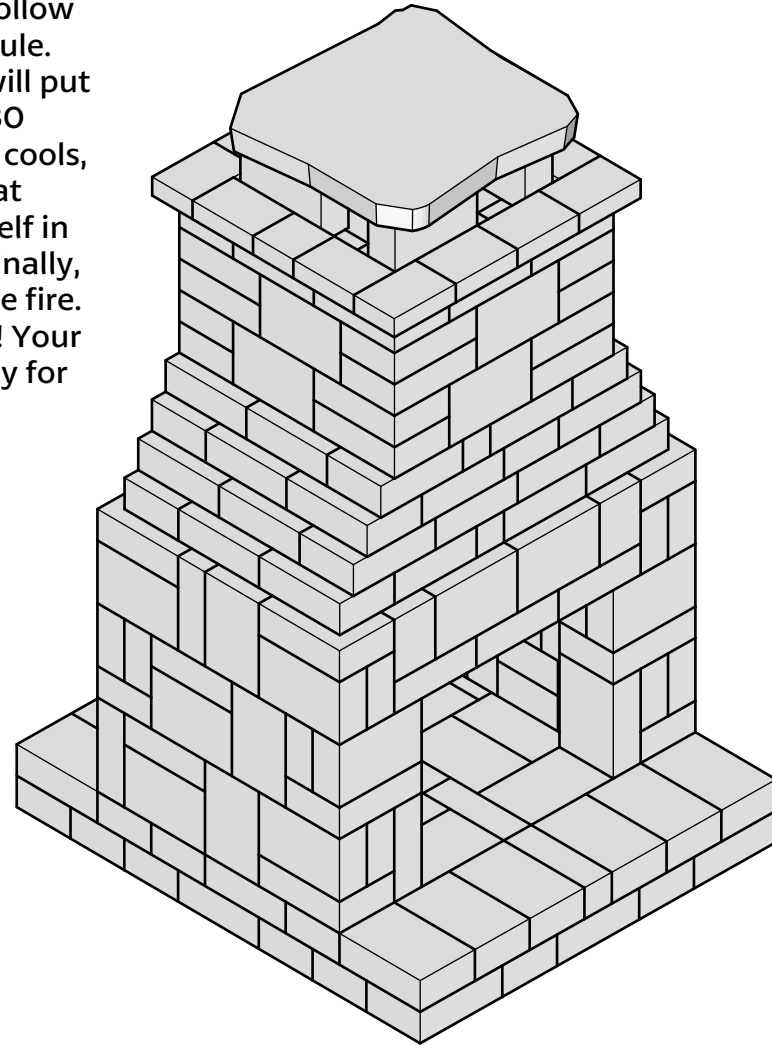

When constructing your project, be sure to keep all blocks level, square, and plumb. Use a four foot level and check often. Starting on a level foundation is key. When gluing blocks together, be sure not to use too much adhesive - this will cause the blocks to "swim." A small bead is ideal.

**Dakota Stone**<sup>TM</sup>

**BUILD WITH  
DAKOTA**

**FPD-5228**

See-Thru Fireplace

REVISIONS

	MM/DD/YY	REMARKS
1	06/04/15	2 SKU and QR update
2	--/--/--	...
3	--/--/--	...
4	--/--/--	...
5	--/--/--	...